



This document is to be used in conjunction with the original manufacturer's manual.

The symbols correspond with the numbered drawings of the original manual.

The reference language for these instructions is French.

GB

04/2024

## Contents

Introduction	1	Fault finding	6
Installation	1	Maintenance	7
Use, safety	3	Conformity with regulation	8
Cleaning and hygiene	5		

## Introduction

The User Manual contains useful information for the user on how to work correctly and in complete safety, and is designed to make it easier to use the machine (called «machine» or «appliance» below).

What follows is in no case intended to be a long list of warnings and constraints, but rather a series of instructions meant to improve the service provided by the machine in every respect, and particularly to avoid a series of injuries or damage to equipment that might result from inappropriate procedures for use and management.

It is essential that all the people responsible for transporting, installing, commissioning, using, maintaining, repairing or dismantling the machine should consult this manual and read it carefully before proceeding with the various operations, in order to avoid any incorrect or inappropriate handling that might be result in damage to the machine or put people's safety at risk.

It is just as important that the Manual should always be available to the operator and it should be kept carefully where the machine

is used ready for easy and immediate consultation in case of any doubt, or in any case, whenever the need arises.

If after reading the Manual, there are still any doubts concerning how to use the machine, please do not hesitate to contact the Manufacturer or approved After Sales Service provider, who is constantly available to ensure quick and careful service for improved machine operation and optimum efficiency.

Note that the safety, hygiene and environmental protection standards currently applicable in the country where the machine is installed must always be applied during all phases of machine operation. Consequently it is the user's responsibility to ensure that the machine is operated and used solely under the optimum safety conditions laid down for people, animals and property.

## Introduction

### 1.1 DESCRIPTION

• These 11.5 and 17.5 litre capacity cutters are machines designed for cookery professionals for mincing, mixing, emulsifying, liquidising, kneading, etc. and can be used to process all types of foodstuffs (meat, vegetables, fruits, condiments, pastry, mayonnaise, etc.).

• For special preparations other than foodstuffs, PLEASE ASK US FOR DETAILS.



- |  |  |
|--|--|
| <b>A</b> Motor cover                     | <b>H</b> Body                                  |
| <b>B</b> Removable funnel                | <b>I</b> Fascia                                |
| <b>C</b> Removable lid arm assembly      | <b>J</b> Mains power switch (17.5l model only) |
| <b>D</b> Transparent BPA-free tritan lid | <b>K</b> Stainless steel housing               |
| <b>E</b> Stainless steel bowl            | <b>L</b> Rubber feet                           |
| <b>F</b> Bowl locking knob               |  |
| <b>G</b> Bowl locking clamps             |  |

## Installation



### ATTENTION!!

Machine storage: -25°C to +50°C

Ambient temperature during operation: +4°C to +40°C

This machine is for professional use and must be used by staff trained to use, clean and maintain it, in terms of reliability and safety. Use the machine in adequately lit premises (See applicable technical standard for the country of use. In Europe, refer to standard EN 12464-1)

When handling the machine, always check that the parts taken hold of are not mobile elements: risk of dropping and injury to the lower limbs.

The machine is not designed for use in explosive atmospheres.

### 2.1 DIMENSIONS - WEIGHT (FOR INFORMATION ONLY) Dimensions of packaging: (L x l x h) mm:

- Gross weight when packaged : 11,5/17,5: 73/83 kg

- Net weight: 11,5/17,5: 59/69 kg

. 11,5l -17,5 modelx : 795 x 515 x 805 mm

. Optional table: 750 x 600 x 200

- Overall dimensions (mm): 2.1

### 2.2 LOCATION

• These machines are designed to be fitted onto a work top (table, base, etc.) of between 400 and 900 mm in height. The four feet ensure that it remains perfectly stable.

• A stainless steel mobile table is available in option for the cutters. 2.1

## 2.3 ELECTRICAL CONNECTION



### ATTENTION !!

Connection to the electrical power supply must be done according to proper professional practice by a qualified and authorised person (see current standards and legislation in the country of installation).

If an adapter is used on the socket, a check must be made that the electrical characteristics of this adapter are not lower than those of the machine.

Do not use multiple plugs

The AC power supply to the machine must comply with the following conditions EN60204-1;

- Maximum voltage variation:  $\pm 10\%$
- Maximum frequency variation:  $\pm 1\%$  on a continuous basis,  $\pm 2\%$  over short periods

**ATTENTION: the electrical installation must comply (for design, creation and maintenance) with the legal and standard requirements in the country where used.**

- Before connecting the machine to the electrical power supply, check that the voltage of the electrical system is the same as that marked on the rating plate.
- The machine's electrical power supply must be protected against voltage surges (short-circuits and excess voltages) using a circuit breaker compliant with IEC60947-2 properly sized, of the appropriate gauge relative to the place of installation and machine specifications - see the specifications shown in column G of figure 2.3a

**ATTENTION: Concerning protection against indirect contact (depending on the type of power supply provided and connection of the exposed conductive parts to the equipotential protection circuit), refer to point 6.3.3 of EN 60204-1 (IEC 60204-1) with the use of protection devices for automatic shut-off of power in the event of an insulation fault with a TN or TT system, or, for the IT system, with the use of a permanent insulation or differentials controller for automatic shut-off. The requirements of IEC 60364-4-41, 413.1 must apply for this protection.**

**For example: in a TN or TT system, a differential circuit breaker must be installed upline of the power supply, with a suitable power cut-off (e.g.: 30 mA) on the earthing installation for the place where it is planned to install the machine.**

**ATTENTION: Failure to comply with these instructions means the customer runs the risk of machine failure and/or accidents due to direct or indirect contacts.**

- The 11,5 and 17,5 litre cutters are only available as standard in three phase, single voltage versions, with two speeds. The 11,5 litre model is also available in single phase supply with speed variation.

• **Motor characteristics:**  **2.3a**



- A** Motor code
- B** Number of phases (3 three phase)
- C** Nominal voltage in volts (value, range or commutation)
- D** Frequency (Hertz)
- E** Motor speed (rpm)
- F** Nominal power (Watts)
- G** Nominal current (Amperes)
- H** Rating of fuse for protecting the electrical line (Amperes)
- I** Indicative electrical consumption (kWh)

**a) Three phase, single voltage 2 speed motor**

- Provide an accessible wall-mounted power outlet standardized with 3 poles + Ground, rated 20 A compliant with IEC60309, and a corresponding waterproof plug to be mounted on the power cord.



The machine must be earthed with the green and yellow wire.

- Check the direction of rotation of the rotor at both speeds:
  - Turn the mains power switch (depending on model) in a clockwise direction  to the I position.
  - Press button **J** (pulse operation) (see § 3.1).
  - Check the direction in which the rotor is turning through the transparent lid (anti-clockwise  - as per the arrow marked on the rotor handle).

- If it is turning in the wrong direction, change over the two phase wires of the plug.

**b) Three phase, single voltage one speed motor with frequency variator**

- The cutter is supplied with a single phase current up to its variator, which transforms the current to supply the three phase motor.
- Provide an accessible standardized wall outlet with 2 poles + ground, rated at 10/16A in accordance with IEC60309, and a corresponding waterproof plug to be installed on the power cord.
- Check that the mains voltage matches that on the rating plate.

• **Warning to the installer:**

This cutter with electronic speed variation is equipped with a filter built into the variator which earths any system interference without passing through the variator. In order to be effective, the installation must have a good quality earth, otherwise the interference could pass through the variator and damage it.



The machine must be earthed with the green and yellow wire.

No earth plug = no protection = risk of breakdown.

**Note: The machine can only be used on TN (earthing to neutral) and TT (earthed neutral) type supplies. Where a machine has to be installed on an IT (impeding or isolated neutral) supply, there is a solution which consists of inserting an isolating transformer and locally putting on the machine on TN or TT supply.**

Note: The earth values are defined according to the residual differential current and must be checked by an electrician.



Damage caused by inadequate earthing is not covered by the guarantee.



In certain circumstances depending on the sensitivity of the protective cut-outs, it may be necessary to install SI-type (super immunity) devices to prevent untimely triggering.

To PAT test the Electrolux Range of Food Preparation Equipment, the PCB board needs to be disconnected before any test is done. This is due to the fact that the boards are fitted with a grounding diode that can give incorrect result during such a test. Also on a standard appliance a flash test of 25 amps and up to 3000v is used but, as you would expect, to use this on equipment, which has a printed circuit, board would be quite destructive to that board. We would recommend the use of a PAT tester approved for computer systems which use a lower rate of amps.

The appliance is perfectly safe and is CE certificated. There are two ways to get overcome this problem.

- Disconnect the board as instructed and test using test for PC's,
- Or install the mixer on a fused spur (no plug) as this takes it away from being a portable appliance and the PAT test is then not needed.

## Use, safety



### ATTENTION !!

Clean the machine properly prior to its first use

This machine is for professional use and must be used by staff trained to use, clean and maintain it, in terms of reliability and safety. Use the machine in adequately lit premises (See applicable technical standard for the country of use. In Europe, refer to standard EN 12464-1)

When handling the machine, always check that the parts taken hold of are not mobile elements: risk of dropping and injury to the lower limbs.

Uncontrolled closure of the lid or ram press involves a risk of crushing the fingers.



**ATTENTION :Risk of burning** .During operation hot liquides can be splashed around the cover by centrifugation.

It is forbidden to open the cover during the job.**Stop the machine and check the total stopping of the nives before opening the cover.**

Never put a hand for insertion area while the machine is in operation; risk of injury. It is strictly forbidden to put the safety systems out of action or modify them: Risk of permanent injury!!!!

Check that the safety devices operate correctly each time before using (see paragraph on «safety system adjustments»).

Never put a hand, a hard or frozen object in the appliance



For health and safety reasons, always use a washable or disposable strong head covering that covers the hair completely.

**ATTENTION: All operations, whether using, cleaning or maintenance, present risks of cuts; never force and always keep hands a reasonable distance from cutting edges.**

**Always use appropriate protective equipment when carrying out these operations.**

The machine is not designed for use in explosive atmospheres.

### 3.1 USER SAFETY IS ENSURED BY:

- User safety is ensured by the following features:
- The motor stops when the lid is unlocked
- The bowl and lid must be locked before the appliance can start
- After a stop, the «start» button must be operated («no voltage» feature)
- The motor is halted by a brake before the rotor can be accessed (models with 2 speeds only)
- Continuous action operation to control the progress of the preparation.
- The standardised size of the lid spout allows products to be added in mid-cycle.
- The design of the bowl (leak prevention tube).
- The bowl, lid and rotor are easy to dismantle for cleaning.

#### - CONTROL PANEL

A,B,E : timer

C : stop button

D : start button

F : increased speed button

G : lower speed button



H : speed indication lamp

I : high speed position II

J : pulse operation button

F-G : variable speed model

#### - The cutters can be started if:

- the lid is correctly locked onto its 4 clamps
  - the lid has been lowered and locked.
  - the mains power switch (K 180 model) is in the start position
- a) Continuous operation: I – II**
- Select ----- on E by pressing and holding button A.
  - Start by pressing button D or button I.
  - For the VV model, the speed can be increased or lowered during operation or when stopped by operating the F or G buttons.
  - Stop by pressing button C.



Always start in low speed then change to a higher speed once the texture of the product changes.

### b) Pulse operation:

- Press button J



- For the variable speed version, use the minimum speed.

### c) Timed operation:

- Select the time on E by pressing keys A or B.
- Start by pressing key D.
- Stop by pressing key C.

Note:

- To change the time during the countdown, press key C then change using A or B, resume the cycle by pressing key D.
- The time selected at the start of the cycle stays stored in the memory.

- To definitively stop the cycle in progress, press key C twice.

### d) Stop:

- Press button C.

Preferably use button C then unlock the lid.

- If the machine is stopped for several days, unplug it to switch off the power supply to the variator

## RESIDUAL RISKS

The machine presents the following residual risks;

- The upper cover of the machine may result in the fingers being crushed if it is closed without being controlled properly.

## 3.2 VARIOUS EQUIPMENT:

- As standard, the cutters have a rotor with two very hard, angled plain stainless steel blades (A), which may be used for the following types of work:

- Mincing of meats and chopping of garlic, onions, etc.
- Preparation of butters, mayonnaise, purées, etc.

- Kneading of all types of doughs/pastries. 3.2a

- A smooth blade rotor (A) is available on request to chop parsley for instance.

- A rotor with toothed blades (B) is available for liquidising shellfish and fish and grinding breadcrumbs, almonds, etc. (please ask for details) 3.2a

- Rotors without cut-outs are available on request, for certain tasks using meat. (speed 1500rpm).

- Speed 1 on a dual speed

- Speed <5 on a variable speed

A Lower inclined perforated knife

B Upper inclined perforated knife 3.2b-c

C Middle flat perforated knife

D Handle

E 15 mm spacer

F 30 mm spacer

G Spacer with shoulder

## 3.3 USE OF THE CUTTERS

- The cutters are supplied with the bowl and the lid fitted and the rotor inside.

Before using the cutters, always check the cleanliness of the bowl, the lid, the rotor and the drive shaft.

- To unlock the lid: 3.3a

Position the scraper handle to the front:



Raise the locking knob.

- To unlock the bowl: 3.3c

1) Hold the bowl by its two handles and turn it in a clockwise direction to release it.

2) Lift it vertically and the rotor will be released automatically. The rotor may also be removed separately.

- To remove the lid from the arm: 3.3d

1) Turn the funnel in an anti-clockwise direction to its stop, so that the key is aligned with the lid cavity.

2) Remove the funnel and tilt the arm backwards to the stop.

- 3.3e

If the scraper is in place, see dismantling §3.4

- To remove the arm assembly from the cutter lid: 3.3f

1) Position the lid vertically so that the two pins of the pivot spindle are aligned with the cut-out in the bushes.

2) Pull the arm vertically to remove it.

- To fit the bowl, lid, arm and funnel, proceed in reverse order.

## 3.4 USE OF THE EQUIPMENT



**Use the scraper 650059 ONLY in combination with microtoothed rotor 650060 K120S.**

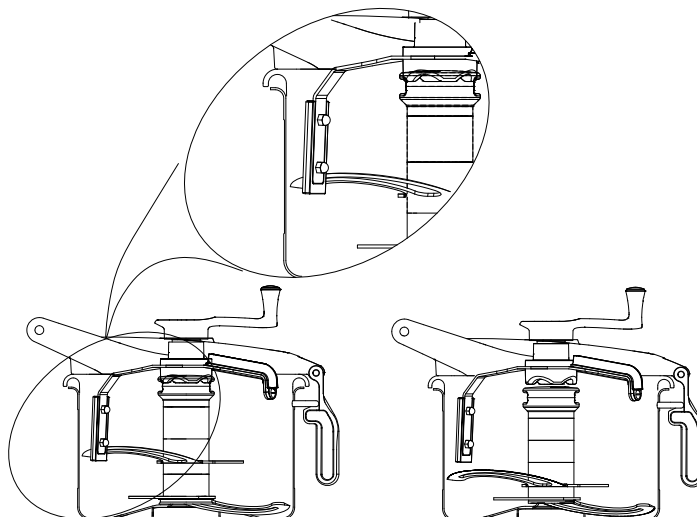

### 3.4 USE OF THE EQUIPMENT

- Always begin in speed I before changing to speed II.
- Use speed I in PULSE mode to start or finish any work which requires attention or precise finishing (see §3.1b).

Note: Liquids or ingredients may be introduced by the lid funnel whilst processing is taking place.

- The height of the central tube of the bowl ensures that liquids will not leak. The maximum level of liquid is indicated on the inside of the bowl.  3.5

- **Fitting the scraper onto the lid:**  3.4A-B

- Fit the scraper **P** underneath in the lid centre hole.
- Position the notch **A** lug opposite the pin housing and lower it to the stop.
- Hold the hub of the scraper in one hand, press the handle then clockwise.  3.4

- **Precaution of use for scraper:**

- Please remove the scraper when mixing frozen or hard products in big pieces (first use the pulse function to fragment them and then re-install the scraper to finish the preparation).
- Do not use the scraper without any products inside the

- The angle of the blades and the setting of the distance between them ensure a rapid and consistent mix.



Never insert your hand or a hard object in the bowl when the machine is in operation.



ALWAYS install the rotor after positioning the bowl

- **To remove the scraper:**

- Hold the scraper hub with one hand and, while exerting pressure between the 2 parts, turn the handle anti-clockwise  (seen from above) to release them.

**Note:**



**When the scraper is not in use, the cover is held in place thanks to the lock cap B (§1.1)**





bowl.



- For consistent homogenisation, we suggest to manually scrape the top part of the bowl once or twice, especially at the beginning immediately after having started the mixing.

### 3.5 SOME POSSIBLE APPLICATIONS

The quantities are given for information purposes only.

- Types of blades plain  

PRODUCTS	REMARKS
<b>MEATS</b> 	All types of stuffing and mousses.
Rough mincing	Cut the meat into pieces and remove bones and nerves. Speed I continuous or pulse mode.
- Terrines	
- Sausages	Short duration (10 to 30 seconds, depending upon the thickness desired).
- Beef burgers	
- Min./max. quantities	200g/5 kg (11,5 l bowl) - 500g/8 kg (17,5 l bowl)
Fine mincing	Speed I until rough mincing is completed then speed II.
- Stuffing	Longer duration (1 to 4 minutes)
- Mousses	Ensure that the blades are kept sharp.
- Min./max. quantities	200g/3 kg (11,5 l bowl) - 500g/5kg (17,5 l bowl)
<b>FRUITS AND VEGETABLES</b> 	Speed I only.
- Purées	For the purée, pour in the hot, drained vegetables then add the fat. Turn to speed I then add the boiling liquid (water, milk, stock, etc.)
- Mousses	
- Stewed fruits	
- Coulis, sorbets	
- Min./max. quantities	 3.1 200g/5 kg (11,5 l bowl) - 500g/8 kg (17,5 l bowl)
<b>CHOPPING VEGETABLES</b> 	The parsley must be dried thoroughly.
- Parsley	Speed I continuous mode then II speed for fine chopping.
- Onion	Use very sharp blades.
- Max. quantities	Avoid using large, juicy onions. Speed II PULSE mode. Fill the bowl
<b>POWDER</b> 	Start in speed I then switch to speed II to obtain the desired smoothness.
- Almonds	For mixtures of equal amounts with crystallised sugar, reduce the sugar using speed II then add the almonds or hazelnuts.
- Hazelnuts	
- Breadcrumbs	
- Shellfish, poultry	
- Max. quantities	3 kg (11.5 l bowl) / 5 kg (17.5 l bowl) } depending upon the volume of the product.

PRODUCTS	REMARKS
<b>KNEADING DOUGH/PASTRY</b> 	Speed I continuous mode, and place all of the ingredients in the bowl: flour, salt, butter and water.
- Shortcrust	
- Shortbread	It only takes a few seconds to prepare the pastry (10 - 15 s)
- Cold water paste	The water used must be cold in order to prevent the pastry from becoming too hot.
- Puff	
- Quiche	For cold water paste, with the maximum quantity, the water must be added to the flour and mixed immediately.
- Min. / Max. quantities	500 g/4 kg of flour (11.5 l bowl) 500g/6 kg of flour (17.5 l bowl)
<b>VARIOUS</b> 	The bowl and the ingredients must be at room temperature.
- Mayonnaise	At speed I PULSE mode to mix eggs, mustard, salt and pepper.
	Change to speed I continuous mode, and gradually pour the oil in until completely emulsified.
	For small quantities, cover the bottom of the bowl with oil and increase the quantity of mustard.
- Max. quantities	3 eggs / 6 litres of oil (11.5 l bowl). 5 eggs / 8 litres of oil (17.5 l bowl).
- Butter sauce for snails	Speed continuous mode II for parsley, garlic, shallots, then add the butter (avoid using cold butter). Then use speed I pulse or continuous mode to mix it all together.
- Max. quantities	3 kg (11.5 l bowl) / 5 kg (17.5 l bowl) } of butter



## ATTENTION !!

Before dismantling any part, disconnect the appliance from the power supply.

Before using any cleaning product, be sure to read the instruction and safety instructions accompanying the product and use appropriate protective equipment.

Do not wash the machine using a pressure washer, a spray or by immersion,

Take care when handling the rotor, screens and plates. (Risk of CUTS – ELECTRIC SHOCK).

### 4.1 IN BETWEEN USE

- Remove the bowl, the lid and the rotor (see §3.3) and remove the seal (NB: It is easier to put back the seal when it is wet).
- Using running water or a bowl of water to clean these parts, use hot water as well as a detergent - degreaser - disinfectant (if working with greasy products).
- Check that the parts have been cleaned properly.
- We strongly recommend sterilising the rotor periodically.

Note:

- Use cleaning products that are compatible with the plastic, stainless steel and aluminium (no chlorinated products) parts.
- Do not use abrasive products to clean the transparent lid.



Handle the rotor carefully (risk of cuts, impacts, etc.).

### 4.2 AFTER USE

- Unplug the machine.
- To remove and clean the rotor, lid and bowl, see §3.3 and 4.1.
- If necessary, clean the outside of the machine with a damp sponge and a detergent - disinfectant, paying particular attention to the rotor drive shaft and the bowl support, then rinse.

Note:

- Use cleaning products that are compatible with the materials of the machine.
- The drive shaft and the inside of the rotor must be kept perfectly clean



Do not disassemble the rotor for cleaning.  
To replace the blades, please refer to Section 6.1



- The bowl, the lid, the seal and the rotor may be cleaned in a dishwasher if the blades are protected against impacts.



Do not wash the machine with a pressure cleaner.

- In order to avoid acid stains on the rotor blades, we recommend that they be dried thoroughly before putting them away, and to keep the rotor in a cold room to limit the development of germs.
- Do not leave the lid on the bowl when the machine is not being used. Keeping it in the open will get rid of condensation and the concentration of lingering odours.

## Fault finding

### 5.1 THE MACHINE WILL NOT START, CHECK THAT:

- The machine is plugged in.
- The electrical power supply to the socket is correct.
- The lid and bowl are correctly locked (see §3.3).
- **If the cutter stops in mid cycle:**
  - The thermal probe of the motor has been triggered. Wait for a few minutes before starting up again.
  - Reduce the quantity of product being processed.
  - Check the mechanical transmission of the machine.
- **For the electronic speed variation models:**
  - Check that the variator is operating correctly by removing the

top cover and the housing.

- If the red LED is lit, call in a specialist.

Note: The first fault detected is stored in the memory. When the power supply to the variator is switched off, the fault is erased. Look for the cause of the fault before resetting and switching the power back on.

- If the green LED is lit, the variator is operating correctly.
- Unplug the machine and check the electrical circuit (see § 6.3)



Respect the safety instructions for dangerous voltages (see § 5.2).

## 5.2 ABNORMAL NOISES OR OPERATION

Stop the machine.

- **Metallic noise**
  - Rotor is rubbing against the bottom of the bowl or is loose.
  - Foreign body in the bowl.
- **Grating noise**
  - Defective belt (see §6.1 for replacement and tensioning instructions)
- **Motor noisy:**
  - Motor operating on two phases. Check the connection and electrical circuit (see electrical wiring diagram §6.3).
- **Lack of power of the variator (model with speed variation)**
  - The electronic variator can limit the power automatically and set itself at a speed lower than that displayed on the potentiometer knob when:
    - . The speed selected is too high (risk of the belt slipping and wearing).
    - . There is too much product in the bowl.
  - Proceed as follows, depending on the cause:

- . Reduce the speed displayed (see §3.3).
- . Reduce the quantity of product (see §3.6).

- **If the direction of rotation is incorrect:**

- The machine must be unplugged.
- Remove the top cover and the housing.



Wait for approximately 1 minute until the capacitors have discharged before touching the inside of the machine. **DANGEROUS VOLTAGE**

- Check that the green LED of the variator is extinguished and remove the plastic cover plate.
- Change over the wires on the U and V terminals. An insulated screwdriver must be used for this operation.
- Fit the plate, housing and cover.
- Plug in the machine and check the direction of rotation.
- Ne pas s'inquiéter du léger bruit de ventilateur lorsque la machine est sous tension, il s'agit d'une caractéristique normale de fonctionnement.

## 5.3 WORK QUALITY

- To obtain perfect and rapid results without overheating:
  - always use sharp, undamaged blades, change them if they have had impacts,
  - use another rotor exclusively for delicate work (e.g. chopping of parsley).

- avoid using excessive quantities of products, which may cause overheating (meat, pastry).

**Note:**

- *The micro-toothed knives have the cutting qualities of a smooth and serrated knife, which reduces sharpening them.*
- *Where necessary, rework the edge of the knives on the side opposite the sharp area using a sharpening stone.*

# Maintenance



## ATTENTION!!

**Unplug the machine before carrying out any operation.**

**Maintenance, including changing the knives, must be carried out by qualified, trained, and authorized persons only.**

**To replace the knives and the spacers on the rotors, please refer to the instructions provided with the separate parts.**

## 6.1 MECHANICAL PARTS

- These cutters only require a minimum amount of maintenance (the motor and the mechanical part bearings are greased for life).
- It is recommended to check the following at least once a year:
  - The tension and wear of the belt.
  - The condition of the electrical connections.
- **To tension or change the belt:**
  - Unplug the machine.
  - Remove the lid and arm in order to separate them from the top cover and remove the bowl (see §3.3).
  - Remove the top cover (four screws) and disconnect the wiring harness (unclip the mains switch for the 17.5 l model).
  - Remove the stainless steel housing.
  - Loosen the four motor attachment screws **A** by two turns (6 mm Allen key).
  - Unscrew the tensioning screw **B**.
  - If the belt is to be changed, lie the machine on its side and remove the base plate (four feet and three screws).
  - Check that the teeth of the belt mesh correctly with the pulley grooves.
  - Tension the belt by tightening **B** with a large screwdriver.
  - Tighten the 4 motor attachment screws solidly.
  - Check that the tension is correct by pinching it between thumb and index finger. The difference between the two sides of the belt should not exceed 15 mm in total.
  - Refit the various parts.

Note: It is absolutely essential to tension the belt correctly. Insufficient or excessive tension will cause transmission problems and even premature wear of the belt or bearings.

- **Access to electrical components.**

- Unplug the machine.
- Remove the top cover (4 screws) and disconnect the wiring harness if necessary.



Residual voltage at the capacitor terminals.

- The capacitors may retain an electrical charge. To avoid taking any risks when carrying out work, we recommend discharging them by connecting their terminals with an insulated conductor (e.g. a screwdriver).

## 6.2 ADJUSTMENT OF THE SAFETY DEVICES

The safety elements must be checked every time prior to use, the motor should stop is less than 4 seconds when the safety guard is opened and the cradle is lowered.

- Check that the safety devices are operating correctly prior to each use. The rotor should stop within less than 4 seconds:
  - when the bowl is unlocked.

- If one of these functions is not implemented:
  - do not use the machine.
  - have it adjusted by the service department of your local dealer.

The opening of the cover when the machine is in operation, measured the opposite side to the hinge, should not exceed 45 mm.

## 6.3 ELECTRICAL COMPONENTS



- Check the condition of the cable and electrical components regularly.

## 6.4 ADDRESS FOR SERVICE REQUIREMENTS

We advise you to contact the dealer who sold you the machine.



For any information or orders for spare parts, specify the type of machine, its serial number and the electrical characteristics.

- The manufacturer reserves the right to modify and make improvements to the products without giving prior warning.

Dealer's stamp

Date of purchase : .....

# Conformity with regulations

**The machine has been designed and manufactured in conformity with:**

- Machine directive 2006/42 EEC
- The CEM directive 2014/30 EU
- 2011/65/EU Directive on the restriction of the use of certain hazardous substances

### 2002/96/CEE « WEEE »

The symbol «  » on the product indicates that this product may not be treated as household waste. Instead it shall be handed over to the applicable collection point for the recycling of electrical and electronic equipment. By ensuring this product is disposed of correctly, you will help prevent potential negative consequences for the environment and human health, which could otherwise be caused by inappropriate waste handling of this product. For more detailed information about recycling of this product, please contact the sales agent or dealer for your product, your after-sales service, or the appropriate waste disposal service.

### 2006/12/CEE "Waste"

The machine is designed so that it does not contribute, or as little as possible, to increasing the quantity or harmfulness of the waste and the risks of pollution.

Make sure to observe the recycling conditions.

### 94/62/CEE "Packaging and packaging waste"

The packaging for the machine is designed so that it does not contribute, or as little as possible to increasing the quantity or harmfulness of the waste and the risks of pollution.

Make sure to eliminate the various parts of the packaging in appropriate recycling centres.

### - To the European standards:

EN 12852 - Culinary preparations. safety and hygiene related presentations.

EN 60 204-1-2006 electrical equipment of machines,

**This conformity is certified by:**

- The CE conformity mark, attached to the machine
- The corresponding CE declaration of conformity, associated with the warranty.
- This instruction manual, which must be given to the operator.

### Acoustic characteristics:

- The acoustic pressure level measured in conformity with the EN ISO 3743.1-EN SIO 3744 <70dbA.

### Protection indices as per the EN 60529-2000 standard:

- IP55 electrical controls
- IP34 overall machine

### Electromagnetic compatibility in compliance with the following standards:

- EN 55014-1: Emission.
- EN 55014-2: Immunity.

### Integrated safety

- The machine has been designed and manufactured in compliance with the relevant standards and regulations, mentioned above.
- Before using the machine, the operator must be trained to use the machine and informed of any possible residual risks .

### Food hygiene:

The machine is made from materials that conform to the following regulations and standards:

- Directive 1935/2004/CEE: Materials and objects in contact with foodstuffs.
- Standard EN 601-2004: cast aluminium alloy objects in contact with foodstuffs.
- Directive EN 1672-2 : Prescriptions relating to hygiene

The surfaces of the food area are smooth and easy to clean. Use detergents that are approved for food hygiene and respect the instructions for their use.

The machine has been CNERPAC approved for food hygiene as well as being granted the Certificate of Sanitary Conformity by the Sanitary Research and Engineering Department.